

Mix5 • Mix8 • Mix12FX

Mix Series Compact Mixers are reliably rugged, with the proven quality you expect from the world leader in compact mixer design.

With proven high-headroom, low-noise design preamps, Mix Series mixers sound great and maintain audio quality from any source. Plus, with their rugged metal chassis and high-quality components throughout, they are a solid investment in reliability.

An amazing value, Mix delivers a straightforward feature set that's easy to use and the sound quality you need in rugged designs built to last.

Features:

- 5, 8 and 12-channel compact mixers with proven high-headroom, low-noise performance
- Mic/line inputs with studio-level audio quality
 - Multi-band EQ with clean, precise tone shaping
 - Pan, level and overload indication
 - Phantom power for studio condenser mics
 - Low cut filter (75 Hz) [Mix12FX]
- Multiple stereo 1/4" line inputs
 - +4/-10 dB and balance operation [Mix12FX]
- One aux send with stereo 1/4" returns [Mix8]
- 12 great-sounding integrated effects including reverbs, choruses and delays [Mix12FX]
- Dedicated stereo RCA inputs/outputs for playback or recording
- Main L/R outputs
- Headphone output
- Stereo control room outputs [Mix8 / Mix12FX]
- Rugged, reliable design built to last
- Extremely compact and portable

Applications:

Live sound mixing, rehearsal spaces, gymnasiums, banquet halls, conference rooms, boardrooms, studio and field recording, multimedia applications and many, many more.



Like us



Follow us



Watch our dang videos

Mix Series Specifications:

Noise Characteristics

(20 Hz – 20 kHz bandwidth, 150 Ω source impedance)	
All outputs, master levels and channel levels off	-100 dBu
All outputs, master levels unity, all channel levels off	-90 dBu
All outputs, master levels unity, 1 channel level unity	-85 dBu

Distortion (THD+N)

(1 kHz, 20 Hz – 20 kHz bandwidth)	
Mic Input to Main Output	<0.01% @+4 dBu output

Attenuation and Crosstalk

(20 Hz–20 kHz bandwidth)	
Inputs to Outputs @ 1 kHz	-85 dB
Main Mix Off @ 1 kHz	-80 dB

Frequency Response

Mic input to any output (gain @ unity)	+0, -1 dB, 20 Hz to 30 kHz
--	----------------------------

Equivalent Input Noise (EIN)

(Mic in to Insert Send out, max gain.)	
150 Ω termination	-125 dBu [Mix5, Mix8] -122 dBu [Mix12FX]

Common Mode Rejection Ratio (CMRR)

(Mic in to Insert Send out, max gain.)	
1 kHz	better than 70 dB

Maximum Levels

Mic inputs (XLR)	+18 dBu [Mix5] +19 dBu [Mix8, Mix12FX]
Aux return in	+16 dBu [Mix8]
All other inputs	+21 dBu
All outputs	+21 dBu

Impedances

Mic in	2 kΩ [Mix5] 3.8 kΩ [Mix8, Mix12FX]
All other inputs	10 kΩ or greater
Tape out	1 kΩ
Phones out	22 Ω
All other outputs	120 Ω unbalanced, 240 Ω balanced

EQ

High Shelving	±15 dB @ 12 kHz
Mid Peaking	±15 dB @ 2.5 kHz
Low Shelving	±15 dB @ 80 Hz
Low Cut Filter	18 dB/octave, -3 dB @ 75 Hz

AC Power Requirements

Mix5/8 Input	AC120V~, 60 Hz [US] AC230-240V~, 50/60 Hz [EU] AC220-230V~, 50/60 Hz [UK] AC220-240V~, 50/60 Hz [AU] AC220V~, 50 Hz [CN] AC127V~, 60 Hz [BZ]
Mix12FX Input	AC120V~, 60 Hz [US] AC230-240V~, 50/60 Hz [EU] AC220-230V~, 50/60 Hz [UK] AC220-240V~, 50/60 Hz [AU] AC220V~, 50 Hz [CN] AC127V~, 60 Hz [BZ]
Mix5/8 Output	AC18V~ 600mA [US] (AC9V~ 300mA)x2 [EU] (AC9V~ 300mA)x2 [UK] (AC9V~ 300mA)x2 [AU] AC18V~ 600mA [CN] AC18V~ 600mA [BZ]
Mix12FX Output	AC18V~ 1000mA [US] (AC9V~ 500mA)x2 [EU] (AC9V~ 500mA)x2 [UK] (AC9V~ 500mA)x2 [AU] (AC9V~ 500mA)x2 [CN] AC18V~ 1000mA [BZ]
Operating Temperature	0° – 40°C 32° – 104°F

Mix Series Specifications Continued:

Physical Properties (product)

Mix5	
Height	1.7 in / 43 mm
Width	5.5 in / 140 mm
Depth	7.7 in / 196 mm
Weight	1.4 lb / 0.6 kg

Mix8	
Height	2.1 in / 53 mm
Width	7.8 in / 198 mm
Depth	9.6 in / 244 mm
Weight	2.5 lb / 1.1 kg

Mix12FX	
Height	2.1 in / 53 mm
Width	11.7 in / 297 mm
Depth	9.6 in / 244 mm
Weight	3.7 lb / 1.7 kg

Physical Properties (packaged product)

Mix5	
Height	3.3 in / 84 mm
Width	6.5 in / 165 mm
Depth	11.3 in / 287 mm
Weight	2.0 lb / 0.9 kg

Mix8	
Height	3.3 in / 84 mm
Width	9.1 in / 231 mm
Depth	13.3 in / 338 mm
Weight	3.0 lb / 1.4 kg

Mix12FX	
Height	3.2 in / 81 mm
Width	13.0 in / 330 mm
Depth	14.6 in / 371 mm
Weight	5.0 lb / 2.3 kg

Ordering Information

Mix5	
Mix5 5-Channel Compact Mixer, US	P/N 2044094-00
Mix5 5-Channel Compact Mixer, EU	P/N 2044094-01
Mix5 5-Channel Compact Mixer, JP	P/N 2044094-02
Mix5 5-Channel Compact Mixer, UK	P/N 2044094-03
Mix5 5-Channel Compact Mixer, AU	P/N 2044094-04
Mix5 5-Channel Compact Mixer, CN	P/N 2044094-05
Mix5 5-Channel Compact Mixer, BZ	P/N 2044094-06

Mix8	
Mix8 8-Channel Compact Mixer, US	P/N 2044095-00
Mix8 8-Channel Compact Mixer, EU	P/N 2044095-01
Mix8 8-Channel Compact Mixer, JP	P/N 2044095-02
Mix8 8-Channel Compact Mixer, UK	P/N 2044095-03
Mix8 8-Channel Compact Mixer, AU	P/N 2044095-04
Mix8 8-Channel Compact Mixer, CN	P/N 2044095-05
Mix8 8-Channel Compact Mixer, BZ	P/N 2044095-06

Mix12FX	
Mix12FX 12-Channel Compact Mixer w/FX, US	P/N 2044096-00
Mix12FX 12-Channel Compact Mixer w/FX, EU	P/N 2044096-01
Mix12FX 12-Channel Compact Mixer w/FX, JP	P/N 2044096-02
Mix12FX 12-Channel Compact Mixer w/FX, UK	P/N 2044096-03
Mix12FX 12-Channel Compact Mixer w/FX, AU	P/N 2044096-04
Mix12FX 12-Channel Compact Mixer w/FX, CN	P/N 2044096-05
Mix12FX 12-Channel Compact Mixer w/FX, BZ	P/N 2044096-06

Mix5 Dimensions

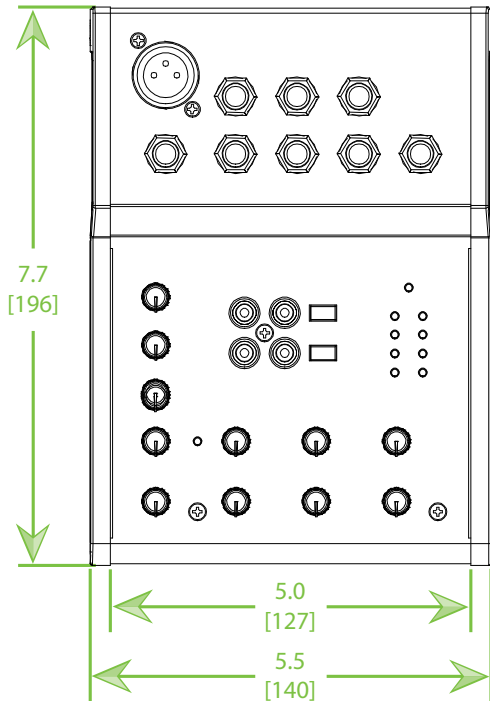

NOTES:

1. WEIGHT APPROX. 1.4 lb [0.6 kg]
2. SHIPPING WEIGHT APPROX. 2.0 lb [0.9 kg]

<p>THIRD ANGLE PROJECTION</p>	<p>UNLESS OTHERWISE SPECIFIED: ALL DIMENSIONS ARE IN INCHES DUAL [MM] DIMENSIONS FOR REF ONLY</p> <p>TOLERANCE IN INCHES LINEAR ± 0.13 in / ± 3.3 mm ANGLES $\pm 1^\circ$</p> <p>(X.XX) = REF DIMS NO TOLERANCE IMPLIED</p> <p>TSC = THEORETICAL SHARP CORNER</p> <p>DIMENSIONS ACROSS CENTERLINES TO BE SYMMETRICAL</p>
<p>THE INFORMATION CONTAINED HEREIN IS PROPRIETARY AND CONFIDENTIAL PROPERTY OF LOUD TECHNOLOGIES, INC. ALL RIGHTS RESERVED</p>	

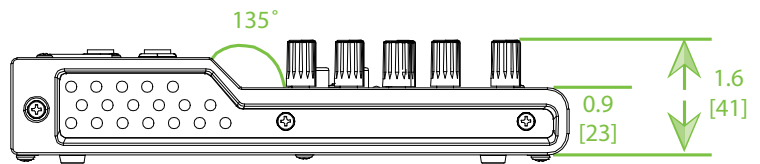
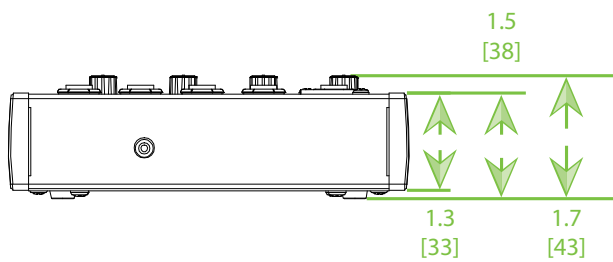

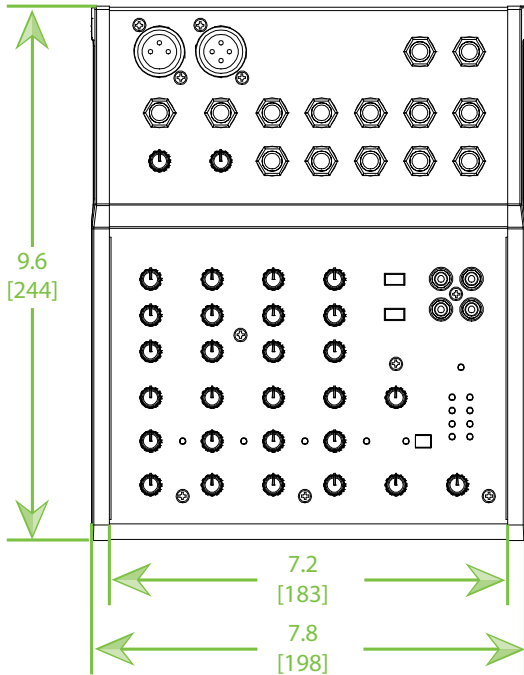
Mix8 Dimensions

NOTES:

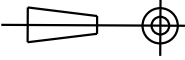
1. WEIGHT APPROX. 2.5 lb [1.1 kg]
2. SHIPPING WEIGHT APPROX. 3.0 lb [1.4 kg]

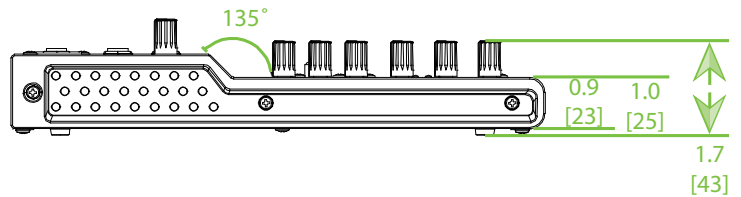
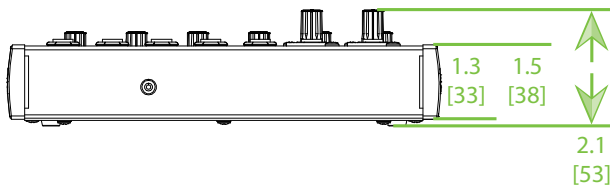
<p>THIRD ANGLE PROJECTION</p> 	<p>UNLESS OTHERWISE SPECIFIED: ALL DIMENSIONS ARE IN INCHES DUAL [MM] DIMENSIONS FOR REF ONLY</p> <p>TOLERANCE IN INCHES LINEAR ± 0.13 in / ± 3.3 mm ANGLES $\pm 1^\circ$</p> <p>(X.XX) = REF DIMS NO TOLERANCE IMPLIED</p> <p>TSC = THEORETICAL SHARP CORNER</p> <p>DIMENSIONS ACROSS CENTERLINES TO BE SYMMETRICAL</p>
<p>THE INFORMATION CONTAINED HEREIN IS PROPRIETARY AND CONFIDENTIAL PROPERTY OF LOUD TECHNOLOGIES, INC. ALL RIGHTS RESERVED</p>	

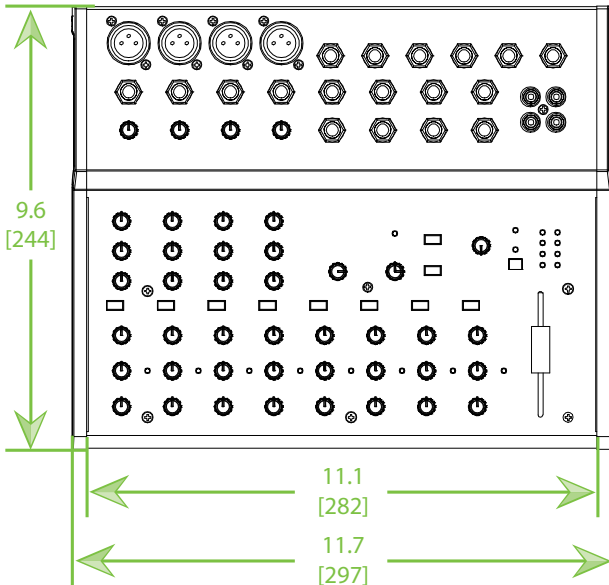

Mix12FX Dimensions

NOTES:

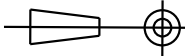
1. WEIGHT APPROX. 3.7 lb [1.7 kg]
2. SHIPPING WEIGHT APPROX. 5.0 lb [2.3 kg]

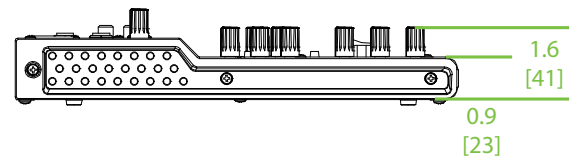
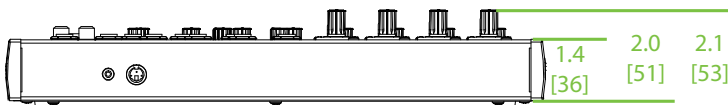
<p>THIRD ANGLE PROJECTION</p> 	<p>UNLESS OTHERWISE SPECIFIED: ALL DIMENSIONS ARE IN INCHES DUAL [MM] DIMENSIONS FOR REF ONLY</p> <p>TOLERANCE IN INCHES LINEAR ± 0.13 in / ± 3.3 mm ANGLES $\pm 1^\circ$</p>
<p>THE INFORMATION CONTAINED HEREIN IS PROPRIETARY AND CONFIDENTIAL PROPERTY OF LOUD TECHNOLOGIES, INC. ALL RIGHTS RESERVED</p>	<p>(X.XX) = REF DIMS NO TOLERANCE IMPLIED</p> <p>TSC = THEORETICAL SHARP CORNER</p> <p>DIMENSIONS ACROSS CENTERLINES TO BE SYMMETRICAL</p>

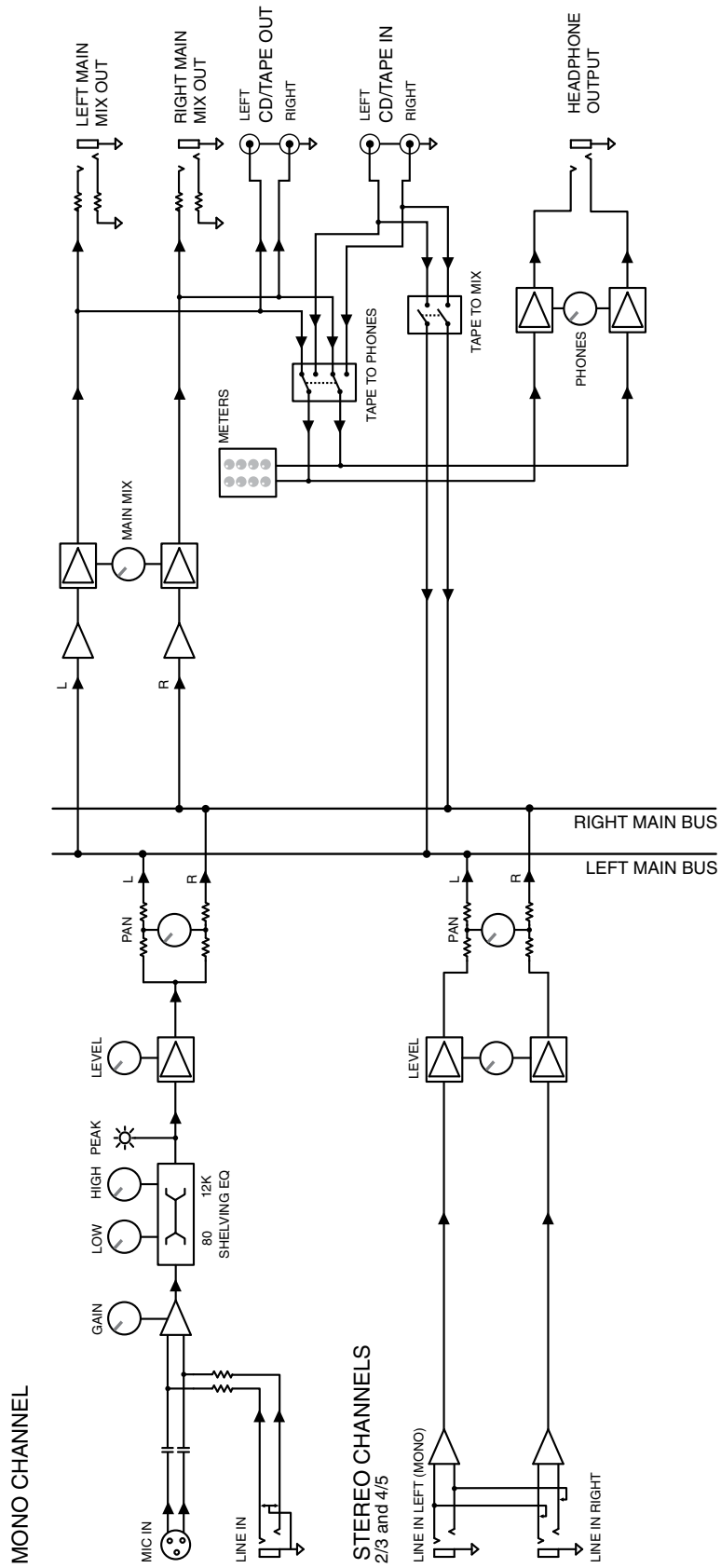

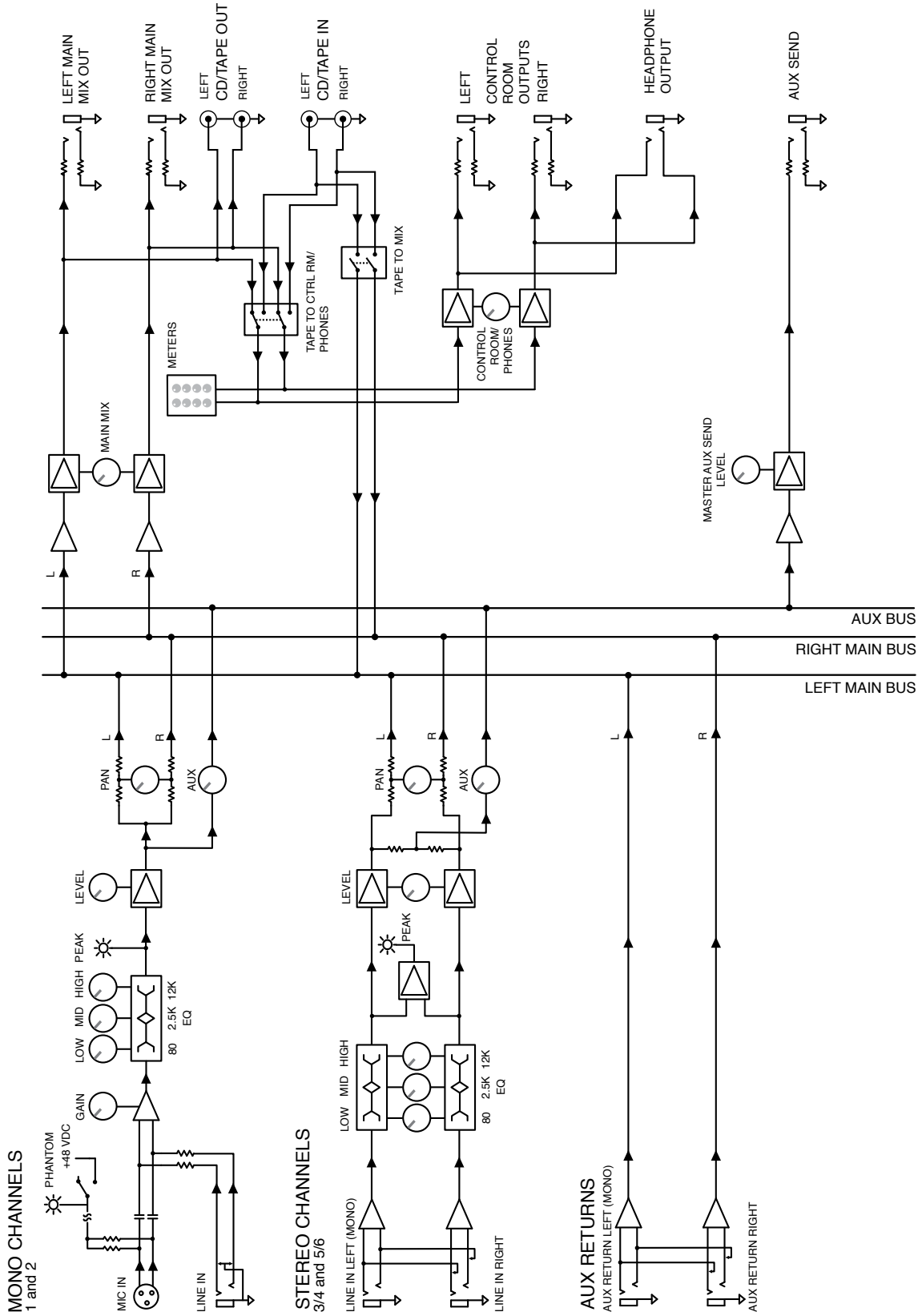
Mix5 Block Diagram

Mix8 Block Diagram

Mix12FX Block Diagram

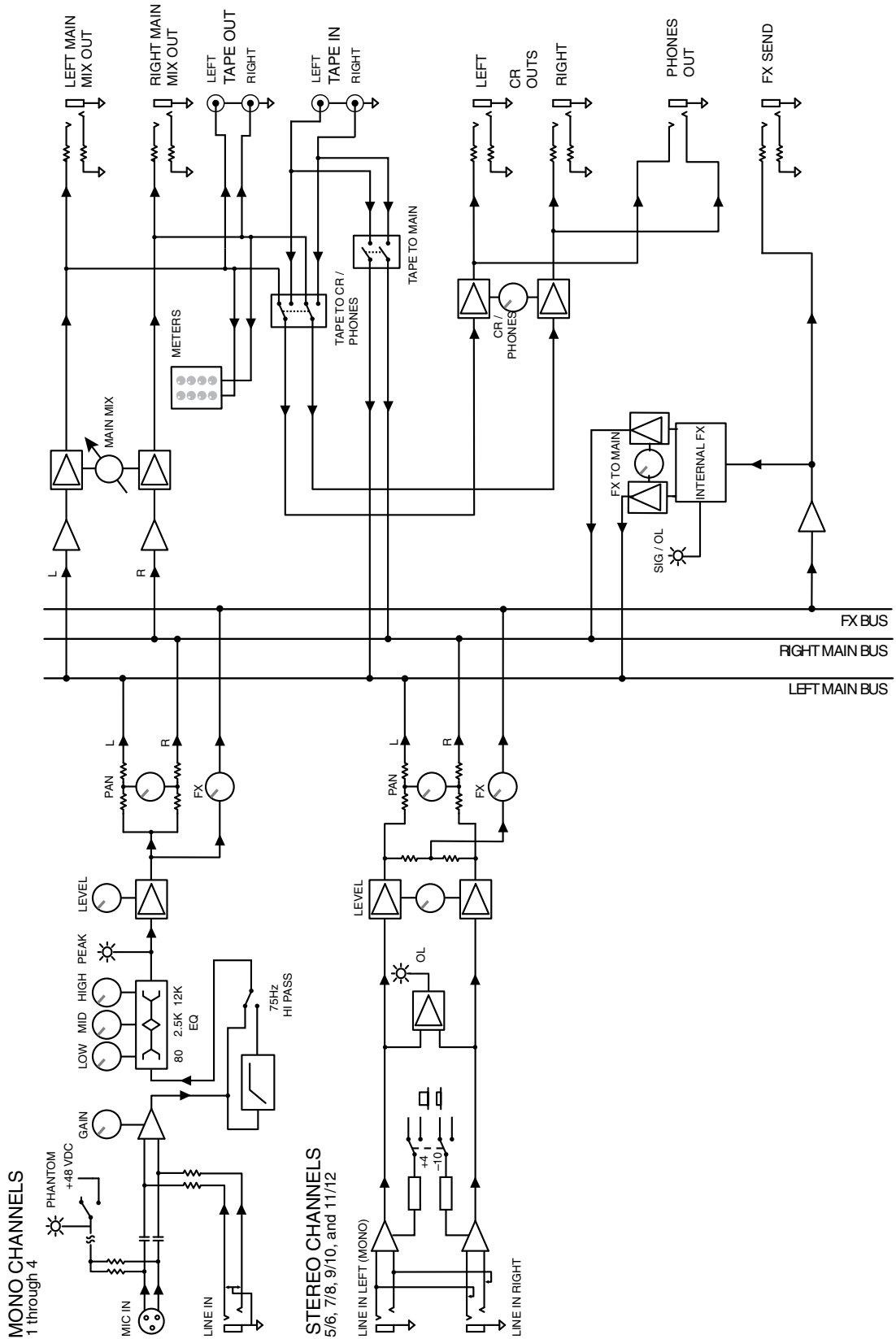

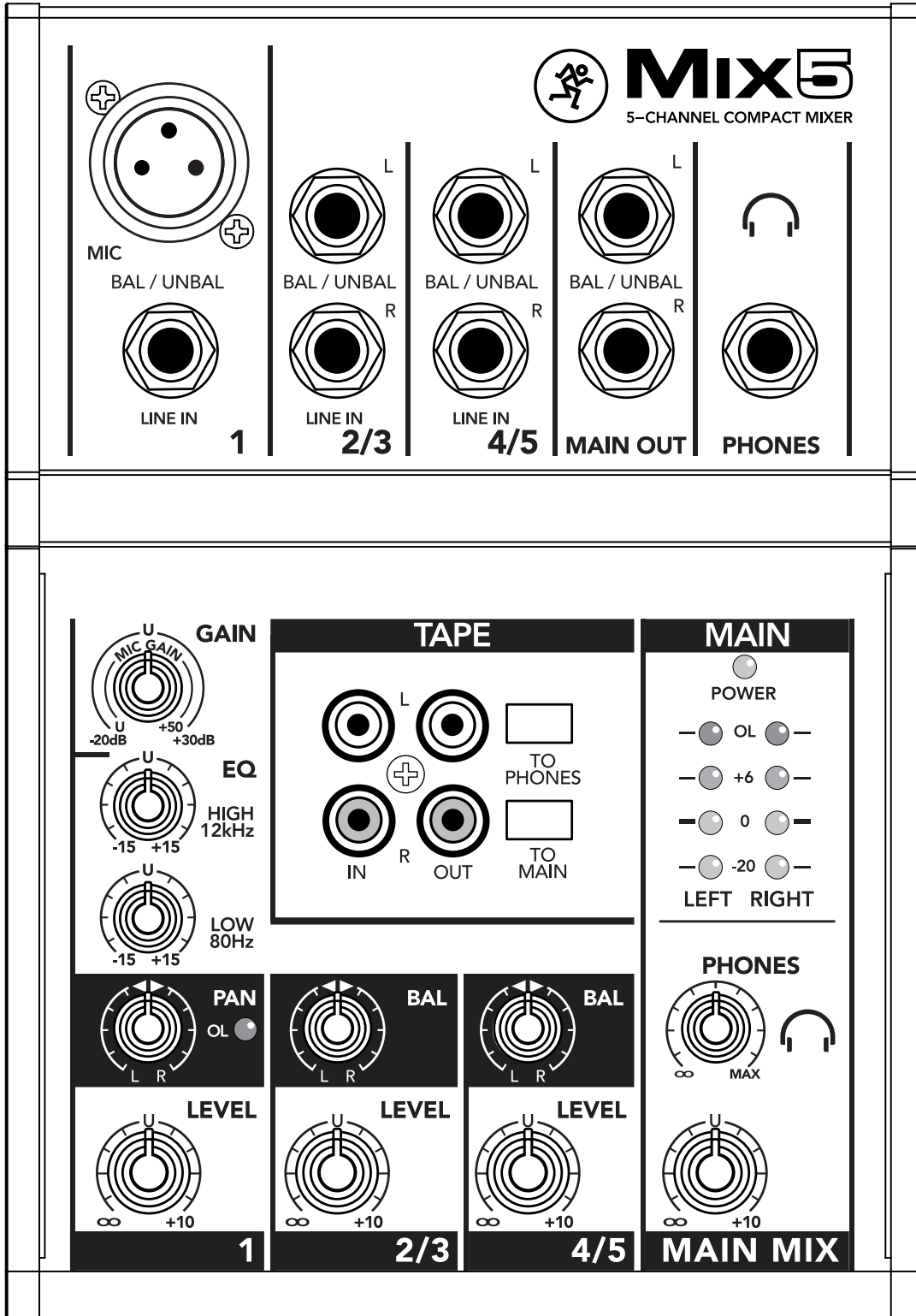
Mix5 Front Panel

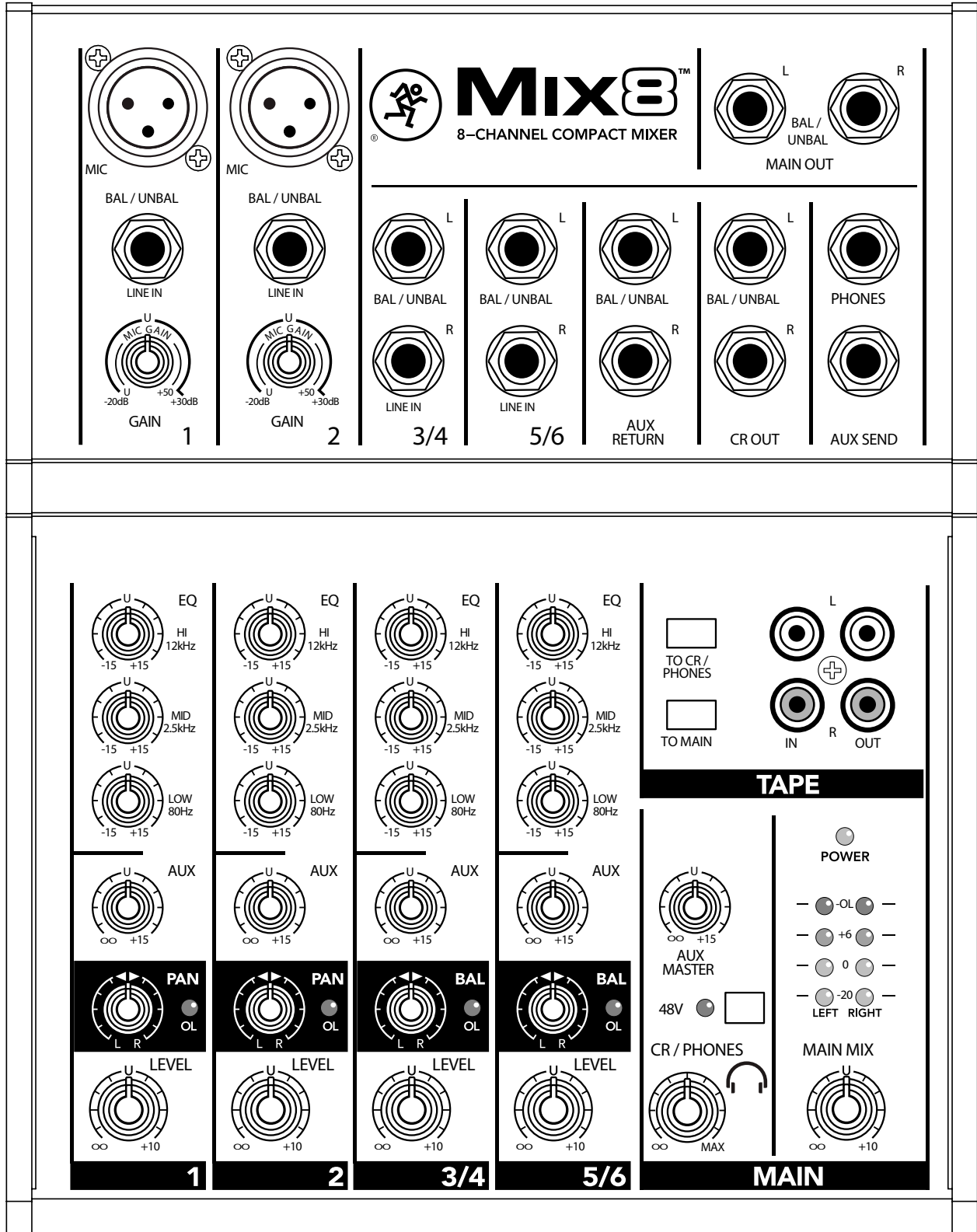
Mix8 Front Panel

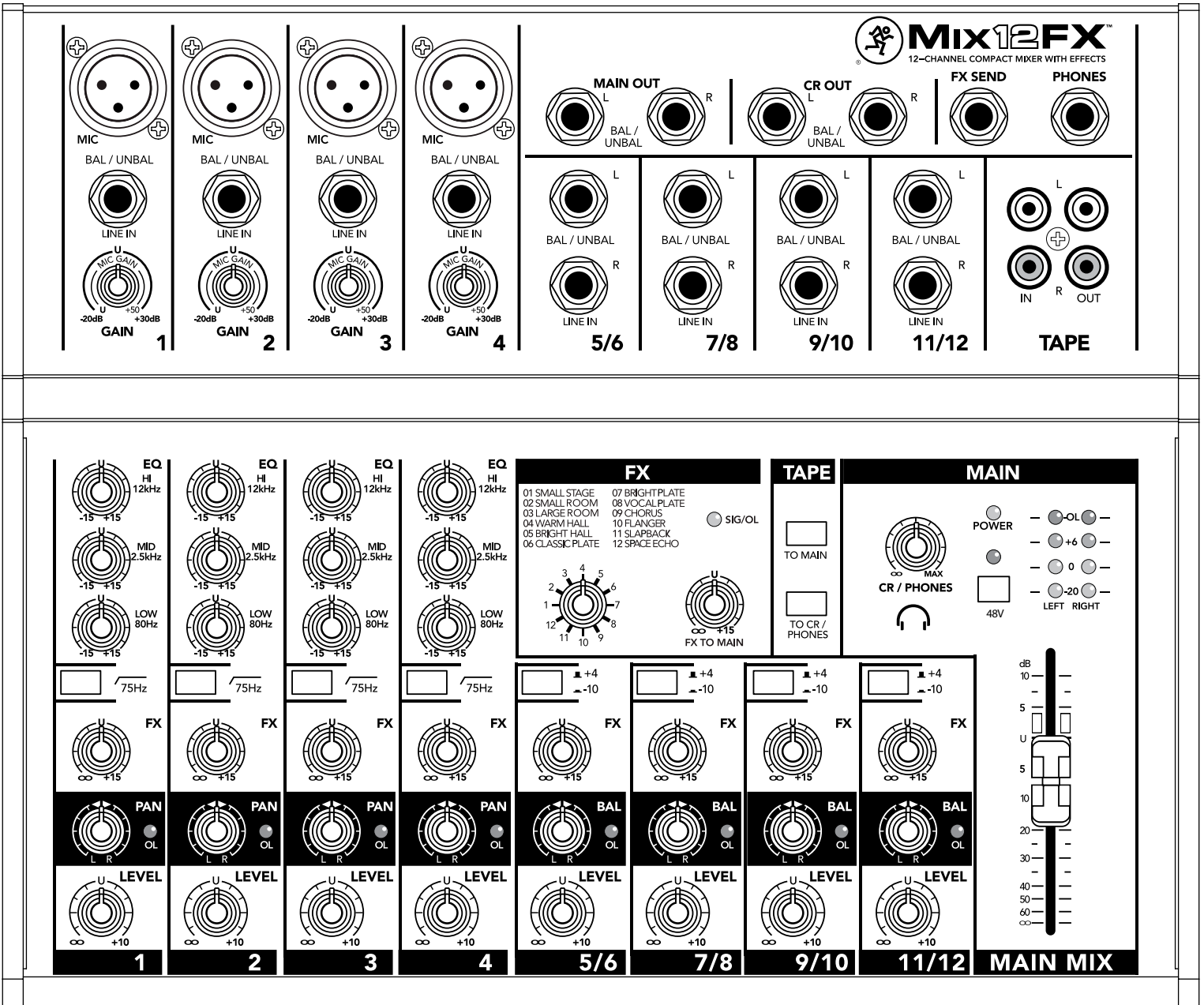
Mix12FX Front Panel

LOUD Technologies Inc. is always striving to improve our products by incorporating new and improved materials, components, and manufacturing methods. Therefore, we reserve the right to change these specifications at any time without notice.

“Mackie” and the “Running Man” figure are registered trademarks of LOUD Technologies Inc. All other brands mentioned are trademarks or registered trademarks of their respective holders, and are hereby acknowledged.

©2015 LOUD Technologies Inc. All rights reserved.

Electronic files for this product are available at:
www.mackie.com

Specification Sheet

Mix_Series_SS.PDF

Owner's Manual

Mix_Series_OM.PDF



www.mackie.com
 16220 Wood-Red Road NE
 Woodinville, WA 98072 USA
 800-898-3211, Fax 425-487-4337

Part No. SW1076 Rev. C 03/15

12/12 PAGES